





Film grips

Suitable for gripping thin films

Selectable from wide range according to sample material and dimension



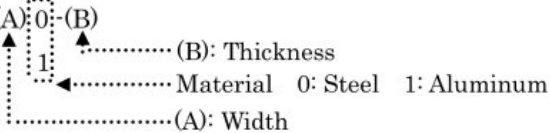

	Light weight aluminum model Suitable for small force measurement because of the light body Capacity:250N(FC-21)	Standard steel model Suitable for big force measurement because of the solid steel body Capacity:500N(FC-20,FC-40)
Standard width Film width: max 20mm Film thickness: max 2mm	FC-21 (Weight:25g) M6 	FC-20 (Weight:73g) M6 
Wide width Film width: max 40mm Film thickness: max 2mm	/	
		FC-40 (Weight:125g) M6 
Custom width Film width: max (A)0mm Film thickness: max (B)mm Please specify numbers for width(A) and thickness(B)	FC-(A)1-(B) (*1)  Contact us for the detail	FC-(A)0-(B) (*1)  Contact us for the detail



*1 FC-(A)0-(B)

Ex) Width 30mm, Steel, Thickness 3mm
 FC-30-3

Ex) Width 15mm, Aluminum, Thickness 1mm
 FC-1.51-1

[Special purpose model]

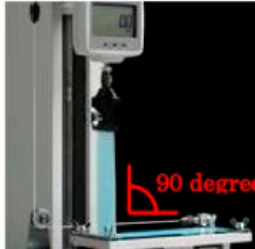
	Light weight aluminum model Capacity:250N (FC-21U,FC-41U,FC-21UQ)	
Single urethane grip model Film width: max 20mm Film thickness: max 2mm	FC-21U (Weight:40g) M6 	Suitable for thin films with the single urethane grip minimizing the possible damage to the sample
Single urethane grip model for wide width Film width: max 40mm Film thickness: max 2mm	FC-41U (Weight:70g) M6 	Wide width model of single urethane grip model
Lever operation single urethane grip model Film width: max 20mm Film thickness: max 0.2mm	FC-21UQ (Weight:50g) M6 	One touch lever operation model of single urethane grip model
Special custom model Please ask us for measurement of special material and dimension	 Contact us for the detail	

Applications		
90 degree peel test Seal adhesive strength test	180 degree peel test Seal adhesive strength test	Film material strength test Strength test of film material
		
JISZ1707(1997)	General rules of plastic films for food packaging	
JISZ0238(1998)	Testing methods for heat sealed flexible packages	
JISZ1711(1994)	Polyethylene film bags	
JISZ1712(1997)	Oriented polypropylene films for packaging	

[Dimension]

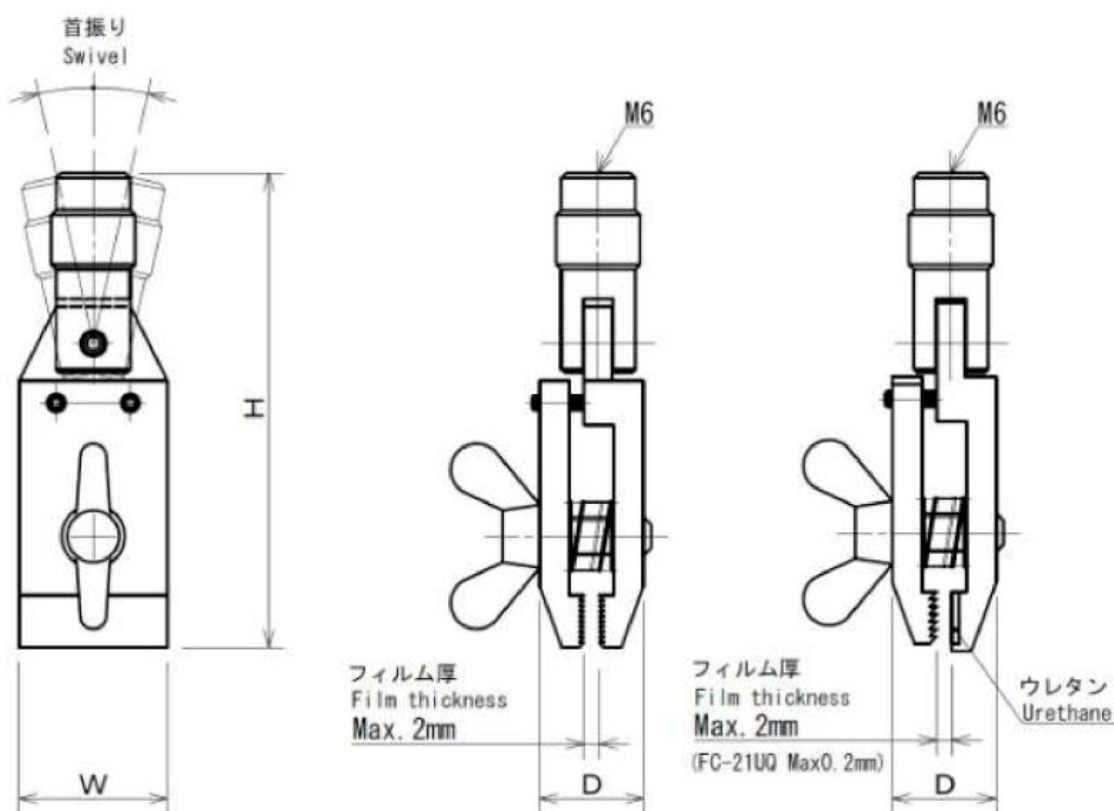

Model	Dimension W*H*D(mm)
FC-21	20*53*8
FC-20	20*64*12
FC-40	40*64*12
FC-21U	20*64.5*12
FC-41U	40*64.5*12
FC-21UQ	20*64.5*12

Differences of models

[General caution]

- The contents may be changed without notice in advance.
- This product is designed for measurement purpose only.
- Some samples of certain material/shape may not be used with these attachments even if it is within specification. Please contact us for the detail.
- Do not copy and use this content without authority.